

Büyük işler
sorumluluk ister
Business need reliability



ürün fiyat kataloğu
product price catalogue

Hakkımızda

about US



İlk olarak 1982 yılında üretim ve pazarlama sektörüne güneş enerjisi ,termosifon ve boiler imalatları ile adım atan Teksan, pazardaki ihtiyaç ve müşteri talepleri doğrultusunda mekanik seperatör üretimine başlamıştır. Mekanik seperatörler denge kabı, tortu tutucu, hava ayırıcı, akümülayon tankları,nötralizasyon ünitesi olarak yurtiçi ve yurtdışında satışa sunulmaktadır. Ayrıca Teksan Satış & Pazarlama bölümü olarak birçok büyük firmanında dağıtıcı bayiliğini üstlenerek müşterilerimize güçlü bir çözüm ortağı olmayı hedeflemiştir. Bugün Teksan olarak 2500 m²si kapalı olmak üzere toplam 7500 m² lik tesisimizde sürekli geliştirdiğimiz makine parkurumuz ve ürün çeşitlerimizle yurtiçi ve yurtdışı pazarda her zaman güvenilir, daha kaliteli ,dinamik ve gün geçtikçe büyüyen bir aile olarak yolunda emin adımlarla devam etmektedir.

Our company has started producing and marketing Solar Water Heater, geyser and boiler since 1982.By the time Teksan started to produce mechanical separators on customer demands. Mechanical separators are Hydraulic separator, dirt separator, air separator, combined separator, (Hydraulic dirt & air separator, and innovative new Hydraulic dirt & air + magnetic separator) and the neutralization tank which are selling at domestic market and also exporting more than 10 different countries. Teksan's SALE & MARKETING department is also the distributor of many big companies (shown at the end of the cat.) of Turkey. We are trying to give you the best and reliable products and service with our 7500 m² factory which process by high tech machinery equipment.



Seperatörler separators



01

Avrupa standartlarında üretim

Production in European norms

02

hızlı teslimat güvenilir ürün

Fast shipping reliable product

03

statik boya

Static dyeing

04

ISO 14001 belgesiyle Türkiye'de tek çevre dostu

Enviromentally friendly with ISO140001 quality certificate



Büyük işler sorumluluk ister
Business need reliability

 www.teksanisi.com



Büyük işler
sorumluluk ister
Business need reliability

contents



İçindekiler

04
15

> **seperatörler & manyetik filtreler**
separators & magnetic filters

16
18

> **nötralizasyon tankları**
neutralization tanks

19
22

> **flaş & kep & yağ tutucu**
flange & cap & oil separator

23
26

> **boyler & tanklar**
boiler & tanks

27
28

> **kaskad bağlantı sistemleri**
kaskad connection systems
kazan yumuşatma cihazları & bağ filtre
boiler softening device & bond filter

29

> **sertifikalar**
certificates





TEKSAN[®]
ISI & DOĞALGAZ MÜHENDİSLİK



DENGE KABI
BİRLEŞİK KAP
HAVA AYIRICI
TORTU TUTUCU
TORTU HAVA AYIRICI

Seperatörler
separators



www.teksanisi.com

Denge Kabı

HYDRAULIC SEPARATOR



TR

Merkezi sistemlerde ısı verimini arttırmak amacı ile kullanılır. Çoğu teknik şartnameler kaskad sistemlerde denge kabı kullanılmasını zorunlu kılmıştır. Bunun sebebi kaskad sistemlerde kullanılan kazan veya kombi pompası ile tesisattaki sirkülasyon pompaları oluşan debi ve basınç farkını ortadan kaldırmaktır.

EN

Our hydraulic separators are designed to offer optimal efficiency of central heating systems. Technical specifications required the hydraulic separators at central heating systems now our hydraulic separators offer the best pressure optimization systemically.



MADE IN TURKEY

teknik detaylar technical details

KOD code	GÜÇ power kW	GİRİŞ-ÇIKIŞ in-out inç	GİRİŞ-ÇIKIŞ in-out DN	M3-SAAAT M3/CLOCK	GALON GALLON	D mm	H cm	A mm	a mm	d mm	B mm	KAYNAKLI FIYAT /PRICE	FLANŞLI FIYAT /PRICE
TDK 001	40 KW	1"	DN 25	1,72	454	76	35	173	159	33,7	216	1.350,00 TL	
TDK 002	50 KW	1 1/4"	DN 32	2,15	567	89	34	189	159	42,4	208	1.462,50 TL	
TDK 003	70 KW	1 1/2"	DN 40	3,01	794	89	39	239	209	48,3	242	1.525,00 TL	2.550,00
TDK 004	115 KW	2"	DN 50	4,95	1306	114	53	237	234	60,3	320	2.050,00 TL	3.375,00 TL
TDK 005	135 KW	2 1/2"	DN 65	5,8	1531	141	60,4	264	281	73	357	2.412,50 TL	3.787,50 TL
TDK 006	185 KW	2 1/2"	DN 65	7,95	2099	169	71	311	329	73	407	3.025,00 TL	4.412,50 TL
TDK 007	235 KW	3"	DN 80	10,1	2667	169	77	359	329	88,9	471	3.775,00 TL	5.375,00 TL
TDK 008	310 KW	3"	DN 80	13,33	3519	219	78	359	379	88,9	411	5.050,00 TL	6.675,00 TL
TDK 009	360 KW	4"	DN 100	15,48	4087	219	88	409	379	114,3	496	5.575,00 TL	7.562,50 TL
TDK 010	510 KW	4"	DN 100	21,93	5790	273	90	463	433	114,3	496	6.875,00 TL	8.900,00 TL
TDK 011	635 KW	5"	DN 125	27,3	7207	273	116	463	433	141	599	8.125,00 TL	10.562,50 TL
TDK 012	760 KW	5"	DN 125	32,68	2652	273	138	463	433	141	809	9.025,00 TL	11.525,00 TL
TDK 013	900 KW	6"	DN 150	38,7	10217	323	143,4	513	433	168,3	812	12.150,00 TL	15.375,00 TL
TDK 014	1150 KW	6"	DN 150	49,45	13055	355	179	585	555	168,3	1032	15.700,00 TL	20.250,00 TL
TDK 015	1600 KW	8"	DN 200	68,8	18163	406	208	672	628	219,1	1300	19.125,00 TL	25.500,00 TL
TDK 016	2000 KW	8"	DN 200	86	22704	457	243	749	697	219,1	1501	21.625,00 TL	28.750,00 TL
TDK 017	2300 KW	8"	DN 200	89,9	23734	508	250	840	788	219,1	1511	24.875,00 TL	33.500,00 TL
TDK 018	2650 KW	10"	DN 250	113,95	30083	559	265	915,5	863,5	273	1377	36.000,00 TL	47.875,00 TL
TDK 019	3550 KW	10"	DN 250	152,65	40300	610	321	948	810	273	1687	42.250,00 TL	56.250,00 TL
TDK 020	5100 KW	12"	DN 300	219,3	57895	800	356	1144	1080	323	2047	53.000,00 TL	80.000,00 TL

* ÜRÜNLERİMİZ - + %5 DEĞİŞKENLİK GÖSTEREBİLİR.

Merkez Ofis (Head Office): İstasyon Caddesi No:29 Bolvadin/Afyonkarahisar
Fabrika (Factory): Selçuklu Mahallesi Ticaret Bölgesi No:316 Bolvadin/Afyonkarahisar
Afyonkarahisar Şube (Branch): Karaman Mh. Alparslan Türkeş Cd. Hisar Apt. No:2/A Afyonkarahisar

Tel: 0 272 612 43 87
Fax: 0 272 612 63 80

web: www.teksanisi.com
e-mail: info@teksanisi.com

Birleşik Kap

COMBINED SEPARATOR



TR

Teksan birleşik kaplar ısıtma veya soğutma tesislerinde hidrolik dengenin yanı sıra tortu ve hava ayırma görevinde üstlenir. Yani birleşik kap ; Denge kabı ,tortu tutucu ve hava ayırıcı kapların görevini tek başına üstlenir

EN

Our hydraulic separators are designed to offer optimal efficiency of central heating systems. Technical specifications required the hydraulic separators at central heating systems now our hydraulic separators offer the best pressure optimization systemically.



MADE IN TURKEY

teknik detaylar technical details

KOD code	GÜÇ power kW	GİRİŞ-ÇIKIŞ in ² - out inç	GİRİŞ-ÇIKIŞ in ² - out DN	M3-SAAAT M3/CLOCK	GALON GALLON	D mm	H cm	A mm	a mm	d mm	B mm	KAYNAKLI FİYAT /PRICE	FLANŞLI FİYAT / PRICE
TBK 001	40 KW	1"	DN 25	1,72	454	76	35	173	159	33,7	203	2.325,00 TL	
TBK 002	50 KW	1 1/4"	DN 32	2,15	567	89	34	189	159	46	214	2.475,00 TL	
TBK 003	70 KW	1 1/2"	DN 40	3,01	794	89	39	239	209	48,3	251,7	2.600,00 TL	4.450,00 TL
TBK 004	115 KW	2"	DN 50	4,95	1306	114	53	264	234	60,3	319,7	3.425,00 TL	5.875,00 TL
TBK 005	135 KW	2 1/2"	DN 65	5,8	1531	141	60,4	311	281	76,1	353,9	4.450,00 TL	7.250,00 TL
TBK 006	185 KW	2 1/2"	DN 65	7,95	2099	169	71	359	329	76,1	403,9	5.550,00 TL	8.375,00 TL
TBK 007	235 KW	3"	DN 80	10,1	2667	169	77	359	329	88,9	451,1	6.925,00 TL	10.225,00 TL
TBK 008	310 KW	3"	DN 80	13,33	3519	219	78	409	379	88,9	451,1	8.475,00 TL	11.625,00 TL
TBK 009	360 KW	4"	DN 100	15,48	4087	219	88	409	379	114,3	495,7	8.500,00 TL	12.025,00 TL
TBK 010	510 KW	4"	DN 100	21,93	5790	273	90	463	433	114,3	455,6	9.950,00 TL	13.125,00 TL
TBK 011	635 KW	5"	DN 125	27,3	7207	273	116	463	433	139,7	730,2	11.375,00 TL	15.300,00 TL
TBK 012	760 KW	5"	DN 125	32,68	2652	273	138	463	433	139,7	910,3	12.600,00 TL	16.700,00 TL
TBK 013	900 KW	6"	DN 150	38,7	10217	323	143,4	513	483	168,3	911,7	17.000,00 TL	22.250,00 TL
TBK 014	1150 KW	6"	DN 150	49,45	13055	355	179	585	555	168,3	1212,7	20.875,00 TL	27.250,00 TL
TBK 015	1600 KW	8"	DN 200	68,8	18163	406	208	672	628	219,1	1371,9	27.000,00 TL	37.375,00 TL
TBK 016	2000 KW	8"	DN 200	86	22704	457	243	749	697	219,1	1660,9	30.625,00 TL	42.250,00 TL
TBK 017	2300 KW	8"	DN 200	89,9	23734	508	250	840	788	219,1	1670,9	35.750,00 TL	49.000,00 TL
TBK 018	2650 KW	10"	DN 250	113,95	30083	559	265	915,5	863,5	273	1687	49.500,00 TL	69.750,00 TL
TBK 019	3550 KW	10"	DN 250	152,65	40300	610	321	948	890	273	2137	59.750,00 TL	81.000,00 TL
TBK 020	5100 KW	12"	DN 300	219,3	57895	800	356	1144	1080	323	2397,2	84.375,00 TL	112.000,00 TL

* ÜRÜNLERİMİZ - + %5 DEĞİŞKENLİK GÖSTEREBİLİR.

Merkez Ofis (Head Office): İstasyon Caddesi No:29 Bolvadin/Afyonkarahisar
Fabrika (Factory):Selçuklu Mahallesi Ticaret Bölgesi No:316 Bolvadin/Afyonkarahisar
Afyonkarahisar Şube (Branch): Karaman Mh. Alparslan Türkeş Cd. Hisar Apt. No:2/A Afyonkarahisar

Tel.:0 272 612 43 87
Fax: 0 272 612 63 80

web: www.teksanisi.com
e-mail: info@teksanisi.com

**TR**

Isıtma ve soğutma sistemlerdeki tesisatlarda kullanılan pislik ayırma aparatıdır. Kazan dönüşüne yerleştirilen tortu tutucu çamur, pislik ve korozyon atığı gibi tortuları tesisattan ayırır. Belirli aralıklarla tortu tutucunun alt kısmındaki vana açılarak biriken tortular kolayca tesisattan uzaklaştırılır. Böylelikle tesisattaki ısınma zorluğu ve verimsizliğin önüne geçilmiş olur.

EN

Dirt separators provide to collect dirt from the system. Dirt separator holds the dirt in its own reservoir to keep the systems efficiency optimized. Separator can be and must be cleaned periodically from the valve at the bottom.

teknik detaylar

technical details

KOD code	GİRİŞ-ÇIKIŞ in - out inç	GİRİŞ-ÇIKIŞ in - out DN	D mm	H cm	A mm	a mm	d mm	B mm	KAYNAKLI FİYAT /PRICE	FLANŞLI FİYAT /PRICE
TTT 001	1"	DN 25	89	23	189	159	33,7	81,9	1.150,00 TL	
TTT 002	1 1/4"	DN 32	89	23	189	159	42,4	73	1.187,50 TL	
TTT 003	1 1/2"	DN 40	114	24	214	184	48,3	79,15	1.625,00 TL	2.250,00 TL
TTT 004	2"	DN 50	114	37	234	204	60,3	115,15	1.950,00 TL	2.725,00 TL
TTT 005	2 1/2"	DN 65	169	40	289	259	73	133,5	2.325,00 TL	3.225,00 TL
TTT 006	3"	DN 80	219	38	409	379	88,9	174,5	3.462,50 TL	4.500,00 TL
TTT 007	4"	DN 100	219	50	409	379	114,3	187,15	4.050,00 TL	5.250,00 TL
TTT 008	5"	DN 125	273	56	463	433	141	210,5	5.300,00 TL	6.875,00 TL
TTT 009	6"	DN 150	323	65,4	513	483	168,3	261,15	7.225,00 TL	9.200,00 TL
TTT 010	8"	DN 200	406	96	698	646	219,1	349,6	16.325,00 TL	19.200,00 TL
TTT 011	10"	DN 250	559	119	897	839	273	476,5	29.500,00 TL	36.525,00 TL
TTT 012	12"	DN 300	610	137	954	890	323	516,5	46.875,00 TL	59.375,00 TL

mini tortu tutucu

mini dirt separator

KOD code	GİRİŞ-ÇIKIŞ in - out inç	GİRİŞ-ÇIKIŞ in - out DN	D mm	H cm	A mm	a mm	d mm	B mm	KAYNAKLI FİYAT /PRICE
TTM 001	1"	DN 25	75	10	110	33,7	33,7	27	1.300,00 TL
TTM 002	1 1/4"	DN 32	89	11	122	42,4	42,4	31	1.350,00 TL
TTM 003	1 1/2"	DN 40	89	12	134	48,3	48,3	34	1.775,00 TL
TTM 004	2"	DN 50	89	12	134	60,3	60,3	40	2.175,00 TL

* ÜRÜNLERİMİZ - + %5 DEĞİŞKENLİK GÖSTEREBİLİR.



Merkez Ofis (Head Office): İstasyon Caddesi No:29 Bolvadin/Afyonkarahisar
 Fabrika (Factory): Selçuklu Mahallesi Ticaret Bölgesi No:316 Bolvadin/Afyonkarahisar
 Afyonkarahisar Şube (Branch): Karaman Mh. Alparslan Türkeş Cd. Hisar Apt. No:2/A Afyonkarahisar



Tel.: 0 272 612 43 87
 Fax: 0 272 612 63 80



web: www.teksanisi.com
 e-mail: info@teksanisi.com

Hava Ayırıcı

AIR SEPARATOR



EN

One of the biggest enemies of mechanic installation are the air bubbles which occur while water passes through from different pressure points. Those bubbles may cause cohesion in the system. Air separators evacuate those bubbles away from system rapidly.



TR

Mekanik tesisatların en büyük düşmanlarından biri kavitasyondur. Kavitasyon tesisatta devirdaim halindeki suyun farklı basınç noktalarından geçerken su içinde ergimiş halde bulunan havanın gaz haline gelerek pompa, boru ve tankların iç yüzeylerine zarar vermesidir. Kavitasyonun başlıca zararları normalin üstünde gürültü, korozyon, pompa problemleri ve verim düşüklüğüdür. Bu sebeple hava ayırıcı kap tesisatın sağlıklı çalışması için hayati öneme sahiptir. Hava ayırıcı, tesisattaki ergimiş veya gaz halindeki havayı sudan ayırarak üst kısmındaki hava ventilleri sayesinde tesisattan uzaklaştırır.



MADE IN TURKEY

teknik detaylar

technical details

KOD code	GİRİŞ-CIKIŞ in - out inç	GİRİŞ-CIKIŞ in - out DN	D mm	H cm	A mm	a mm	d mm	B mm	KAYNAKLI FIYAT /PRICE	FLANŞLI FIYAT /PRICE
THA 001	1"	DN 25	89	25	189	159	33,7	76,9	1.287,50 TL	
THA 002	1 1/4"	DN 32	89	26	189	159	42,4	73	1.325,00 TL	
THA 003	1 1/2"	DN 40	114	30	214	184	48,3	79,15	1.850,00 TL	2.575,00 TL
THA 004	2"	DN 50	114	390	234	204	60,3	105,15	1.850,00 TL	3.125,00 TL
THA 005	2 1/2"	DN 65	169	430	289	259	73	131,5	2.700,00 TL	3.712,50 TL
THA 006	3"	DN 80	219	510	409	379	88,9	189,45	3.975,00 TL	5.150,00 TL
THA 007	4"	DN 100	219	550	409	379	114,3	222,15	4.450,00 TL	5.775,00 TL
THA 008	5"	DN 125	273	590	463	433	141	275,5	5.875,00 TL	7.450,00 TL
THA 009	6"	DN 150	323	684	513	483	168,3	311,15	7.950,00 TL	10.125,00 TL
THA 010	8"	DN 200	406	930	698	646	219,1	465	16.325,00 TL	19.200,00 TL
THA 011	10"	DN 250	559	124	897	839	273	571,9	29.500,00 TL	36.525,00 TL
THA 012	12"	DN 300	610	127	960	890	323	596,5	46.875,00 TL	59.375,00 TL

mini hava ayırıcı

mini air separator

KOD code	GİRİŞ-CIKIŞ in - out inç	GİRİŞ-CIKIŞ in - out DN	D mm	H cm	A mm	a mm	d mm	B mm	KAYNAKLI FIYAT /PRICE
THM 001	1"	DN 25	75	10	110	33,7	33,7	27	1.400,00 TL
THM 002	1 1/4"	DN 32	89	11	122	42,4	42,4	31	1.462,50 TL
THM 003	1 1/2"	DN 40	89	12	134	48,3	48,3	34	2.062,50 TL
THM 004	2"	DN 50	89	12	134	60,3	60,3	40	2.375,00 TL

* ÜRÜNLERİMİZ - + %5 DEĞİŞKENLİK GÖSTEREBİLİR.

Merkez Ofis (Head Office): İstasyon Caddesi No:29 Bolvadin/Afyonkarahisar
Fabrika (Factory): Selçuklu Mahallesi Ticaret Bölgesi No:316 Bolvadin/Afyonkarahisar
Afyonkarahisar Şube (Branch): Karaman Mh. Alparslan Türkeş Cd. Hisar Apt. No:2/A Afyonkarahisar

Tel: 0 272 612 43 87
Fax: 0 272 612 63 80

web: www.teksanisi.com
e-mail: info@teksanisi.com

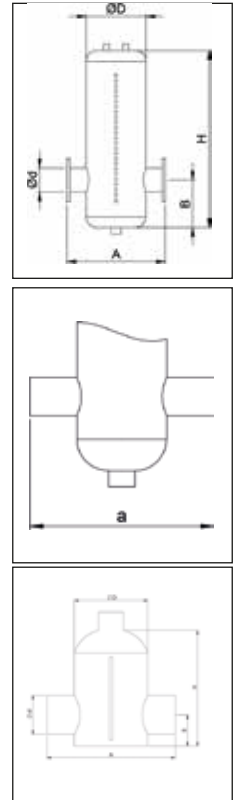

Tortu Hava Ayırıcı

DIRT & AIR SEPARATOR



TEKSAN
İSİ & DOĞALGAZ MÜHENDİSLİK

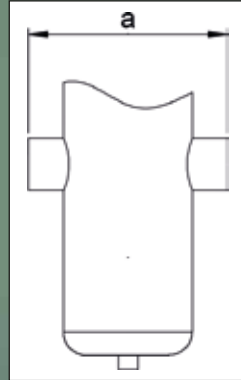
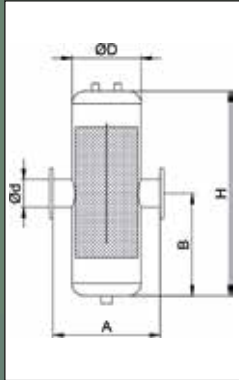

TR

Kazan sistemlerinde, yerden ısıtma sistemlerinde ve soğutma sistemlerinde tesisat suyunda oluşan hava ve tortuları ayıran mekanik seperatörlerdir.

Tesisat suyunda oluşan tortu ve hava kabarcıkları (kavitasyon) tesisat, pompa ve kazanın verimini düşürüp ömrünü azaltır. Teksan tortu-hava ayırıcı kap tortu tutucu ve hava ayırıcı kapların görevini tek başına yerine getirir.

EN

As technical specifications required you may prefer Dirt & Air separator instead.



MADE IN TURKEY



teknik detaylar technical details

KOD code	GİRİŞ-ÇIKIŞ in - out inç	GİRİŞ-ÇIKIŞ in - out DN	D mm	H cm	A mm	a mm	d mm	B mm	KAYNAKLI FİYAT / PRICE	FLANŞLI FİYAT / PRICE
TTHK 001	1"	DN 25	89	25	189	159	33,7	76,9	1.525,00 TL	
TTHK 002	1 1/4"	DN 32	89	26	189	159	42,4	73	1.575,00 TL	
TTHK 003	1 1/2"	DN 40	114	30	214	184	48,3	79,15	2.225,00 TL	3.075,00 TL
TTHK 004	2"	DN 50	114	39,0	234	204	60,3	105,15	2.687,50 TL	3.725,00 TL
TTHK 005	2 1/2"	DN 65	169	43,0	289	259	73	131,5	3.200,00 TL	4.450,00 TL
TTHK 006	3"	DN 80	219	51,0	409	379	88,9	189,45	4.750,00 TL	6.175,00 TL
TTHK 007	4"	DN 100	219	55,0	409	379	114,3	222,15	5.325,00 TL	6.925,00 TL
TTHK 008	5"	DN 125	273	59,0	463	433	141	275,5	7.000,00 TL	8.925,00 TL
TTHK 009	6"	DN 150	323	68,4	513	483	168,3	311,15	9.525,00 TL	12.150,00 TL
TTHK 010	8"	DN 200	406	93,0	698	646	219,1	465	17.750,00 TL	21.000,00 TL
TTHK 011	10"	DN 250	559	124	897	839	273	571,9	32.250,00 TL	39.750,00 TL
TTHK 012	12"	DN 300	610	127	960	890	323	596,5	51.000,00 TL	64.125,00 TL

* ÜRÜNLERİMİZ - + %5 DEĞİŞKENLİK GÖSTEREBİLİR.

Merkez Ofis (Head Office): İstasyon Caddesi No:29 Bolvadin/Afyonkarahisar
Fabrika (Factory): Selçuklu Mahallesi Ticaret Bölgesi No:316 Bolvadin/Afyonkarahisar
Afyonkarahisar Şube (Branch): Karaman Mh. Alparslan Türkeş Cd. Hisar Apt. No:2/A Afyonkarahisar

Tel: 0 272 612 43 87
Fax: 0 272 612 63 80

web: www.teksanisi.com
e-mail: info@teksanisi.com



TEKSAN®

ISI & DOĞALGAZ MÜHENDİSLİK



MANYETİK DENGELİ KABİ
MANYETİK BİRLEŞİK KAP
MANYETİK TORTU ve PİSLİK TUTUCU
MANYETİK STANDART FİLTRE
MANYETİK CEPLİ FİLTRE

Manyetik Seperatörler magnetic separators



www.teksanisi.com

Denge Kabı & Manyetik Filtre

HYDRAULIC SEPARATOR & MAGNETIC FILTER



TEKSAN
ISI & DOĞALGAZ MÜHENDİSLİK

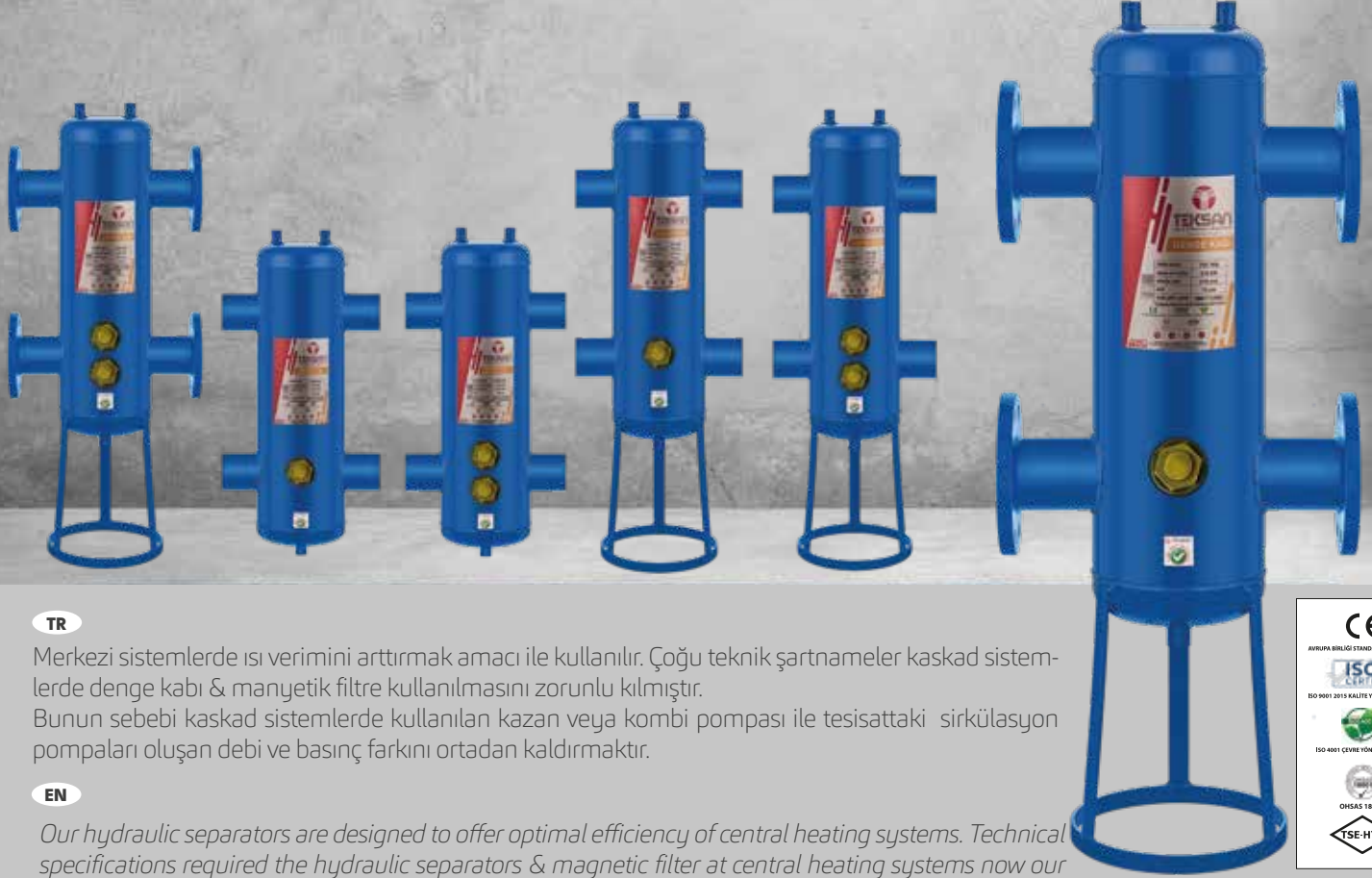

TR

Merkezi sistemlerde ısı verimini arttırmak amacı ile kullanılır. Çoğu teknik şartnameler kaskad sistemlerde denge kabı & manyetik filtre kullanılmasını zorunlu kılmıştır. Bunun sebebi kaskad sistemlerde kullanılan kazan veya kombi pompası ile tesisattaki sirkülasyon pompaları oluşan debi ve basınç farkını ortadan kaldırmaktır.

EN

Our hydraulic separators are designed to offer optimal efficiency of central heating systems. Technical specifications required the hydraulic separators & magnetic filter at central heating systems now our hydraulic separators & magnetic filter offer the best pressure optimization systemically.



MADE IN TURKEY

teknik detaylar

KOD code	GÜÇ power KW	GİRİŞ-ÇIKIŞ in-out inç	GİRİŞ-ÇIKIŞ in-out DN	M3-SAAT M3/CLOCK	GALON GALLON	D mm	H cm	A mm	a mm	d mm	B mm	KAYNAKLI FIYAT /PRICE	FLANŞLI FIYAT /PRICE
TDMF 001	40 KW	1"	DN 25	1,72	454	76	35	173	159	33,7	216	3.600,00 TL	
TDMF 002	50 KW	1 1/4"	DN 32	2,15	567	89	34	189	159	42,4	208	3.750,00 TL	
TDMF 003	70 KW	1 1/2"	DN 40	3,01	794	89	39	239	209	48,3	242	3.900,00 TL	5.600,00 TL
TDMF 004	115 KW	2"	DN 50	4,95	1306	114	53	237	234	60,3	320	4.600,00 TL	7.000,00 TL
TDMF 005	135 KW	2 1/2"	DN 65	5,8	1531	141	60,4	264	281	73	357	4.950,00 TL	7.900,00 TL
TDMF 006	185 KW	2 1/2"	DN 65	7,95	2099	169	71	311	329	73	407	5.800,00 TL	8.700,00 TL
TDMF 007	235 KW	3"	DN 80	10,1	2667	169	77	359	329	88,9	471	6.600,00 TL	9.900,00 TL
TDMF 008	310 KW	3"	DN 80	13,33	3519	219	78	359	379	88,9	411	8.100,00 TL	11.000,00 TL
TDMF 009	360 KW	4"	DN 100	15,48	4087	219	88	409	379	114,3	496	8.950,00 TL	12.100,00 TL
TDMF 010	510 KW	4"	DN 100	21,93	5790	273	90	463	433	114,3	496	10.400,00 TL	13.500,00 TL
TDMF 011	635 KW	5"	DN 125	27,3	7207	273	116	463	433	141	599	11.600,00 TL	15.500,00 TL
TDMF 012	760 KW	5"	DN 125	32,68	2652	273	138	463	433	141	809	12.200,00 TL	16.300,00 TL
TDMF 013	900 KW	6"	DN 150	38,7	10217	323	143,4	513	433	168,3	812	15.600,00 TL	20.850,00 TL
TDMF 014	1150 KW	6"	DN 150	49,45	13055	355	179	585	555	168,3	1032	18.900,00 TL	25.250,00 TL
TDMF 015	1600 KW	8"	DN 200	68,8	18163	406	208	672	628	219,1	1300	22.600,00 TL	32.900,00 TL
TDMF 016	2000 KW	8"	DN 200	86	22704	457	243	749	697	219,1	1501	24.200,00 TL	35.800,00 TL
TDMF 017	2300 KW	8"	DN 200	89,9	23734	508	250	840	788	219,1	1511	28.750,00 TL	41.900,00 TL
TDMF 018	2650 KW	10"	DN 250	113,95	30083	559	265	915,5	863,5	273	1377	41.000,00 TL	60.800,00 TL
TDMF 019	3550 KW	10"	DN 250	152,65	40300	610	321	948	810	273	1687	48.500,00 TL	69.500,00 TL
TDMF 020	5100 KW	12"	DN 300	219,3	57895	800	356	1144	1080	323	2047	59.200,00 TL	86.800,00 TL

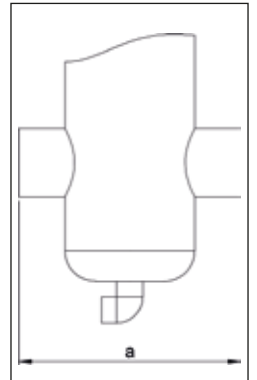
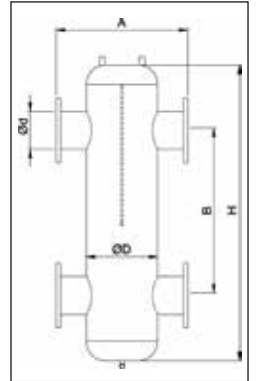

* ÜRÜNLERİMİZ - + %5 DEĞİŞKENLİK GÖSTEREBİLİR.

Merkez Ofis (Head Office): İstasyon Caddesi No:29 Bolvadin/Afyonkarahisar
Fabrika (Factory): Selçuklu Mahallesi Ticaret Bölgesi No:316 Bolvadin/Afyonkarahisar
Afyonkarahisar Şube (Branch): Karaman Mh. Alparslan Türkeş Cd. Hisar Apt. No:2/A Afyonkarahisar

Tel: 0 272 612 43 87
Fax: 0 272 612 63 80

web: www.teksanisi.com
e-mail: info@teksanisi.com

Birleşik Kab & Manyetik Filtre

COMBINED SEPARATOR & MAGNETIC FILTER



TR

Birleşik kap ve manyetik filtre merkezi sistemlerde denge kabı, hava ayırıcı ve tortu tutucu işlemine ek olarak, sistem içerisindeki sıvıda bulunan metal parçacıkları toplarlar. Flaşlı ve Dişli olarak sisteme montajı yapılır ihtiyaca göre gövdede bulunan neodyum çubuk mıknatıs adetleri artırılıp eksiltilebilir mıknatıslar gövdenin dışında bulunan pirinç tapa sayesinde sökülüp takılabilir mıknatıslar, manyetik kir parçacıklarından arındırmak için çıkarılıp temizlenmesi gerekir. Bu ürün sayesinde denge kabı ve hava ayırıcı işlemini de yerine getirir, sistemde demir parçası, tortu, çamur ve pislik tek ürün kullanılarak arındırılmış olur tortu çamur ve pislik temizliği ürün altında bulunan tahliye vanasından boşaltımı sağlanır.

EN

Combined vessel and magnetic filter In central systems, in addition to the balance vessel, air separator and sediment holder, it collects metal particles in the liquid in the system. It is mounted to the system as flanged and threaded. The number of neodymium bar magnets in the body can be increased or decreased depending on the need, magnets that can be removed and cleaned thanks to the brass plug located outside the body, magnetic dirt particles must be removed and cleaned. Thanks to this product, it performs the operation of the balance tank and air separator, the iron part, tou, mud and dirt are purified by using a single product in the system.



MADE IN TURKEY

teknik detaylar technical details

KOD code	GÜÇ power KW	GİRİŞ-ÇIKIŞ in - out inç	GİRİŞ-ÇIKIŞ in - out DN	M3-SAAT M3/CLOCK	GALON GALLON	D mm	H cm	A mm	a mm	d mm	B mm	KAYNAKLI FIYAT / PRICE	FLANŞLI FIYAT / PRICE
TBMF 001	40 KW	1"	DN 25	1,72	454	76	35	173	159	33,7	203	6.375,00 TL	
TBMF 002	50 KW	1 1/4"	DN 32	2,15	567	89	34	189	159	46	214	6.625,00 TL	
TBMF 003	70 KW	1 1/2"	DN 40	3,01	794	89	39	239	209	48,3	251,7	6.725,00 TL	8.500,00 TL
TBMF 004	115 KW	2"	DN 50	4,95	1306	114	53	264	234	60,3	319,7	8.937,50 TL	11.375,00 TL
TBMF 005	135 KW	2 1/2"	DN 65	5,8	1531	141	60,4	311	281	76,1	353,9	9.750,00 TL	12.750,00 TL
TBMF 006	185 KW	2 1/2"	DN 65	7,95	2099	169	71	359	329	76,1	403,9	11.000,00 TL	13.925,00 TL
TBMF 007	235 KW	3"	DN 80	10,1	2667	169	77	359	329	88,9	451,1	12.375,00 TL	15.675,00 TL
TBMF 008	310 KW	3"	DN 80	13,33	3519	219	78	409	379	88,9	451,1	13.375,00 TL	16.375,00 TL
TBMF 009	360 KW	4"	DN 100	15,48	4087	219	88	409	379	114,3	495,7	13.875,00 TL	17.000,00 TL
TBMF 010	510 KW	4"	DN 100	21,93	5790	273	90	463	433	114,3	455,6	14.950,00 TL	18.125,00 TL
TBMF 011	635 KW	5"	DN 125	27,3	7207	273	116	463	433	139,7	730,2	16.375,00 TL	20.300,00 TL
TBMF 012	760 KW	5"	DN 125	32,68	2652	273	138	463	433	139,7	910,3	17.600,00 TL	21.700,00 TL
TBMF 013	900 KW	6"	DN 150	38,7	10217	323	143,4	513	483	168,3	911,7	22.000,00 TL	27.250,00 TL
TBMF 014	1150 KW	6"	DN 150	49,45	13055	355	179	585	555	168,3	1212,7	25.875,00 TL	32.250,00 TL
TBMF 015	1600 KW	8"	DN 200	68,8	18163	406	208	672	628	219,1	1371,9	32.000,00 TL	42.375,00 TL
TBMF 016	2000 KW	8"	DN 200	86	22704	457	243	749	697	219,1	1660,9	35.625,00 TL	47.250,00 TL
TBMF 017	2300 KW	8"	DN 200	89,9	23734	508	250	840	788	219,1	1670,9	40.750,00 TL	54.000,00 TL
TBMF 018	2650 KW	10"	DN 250	113,95	30083	559	265	915,5	863,5	273	1687	54.500,00 TL	74.375,00 TL
TBMF 019	3550 KW	10"	DN 250	152,65	40300	610	321	948	890	273	2137	64.750,00 TL	86.000,00 TL
TBMF 020	5100 KW	12"	DN 300	219,3	57895	800	356	1144	1080	323	2397,2	89.375,00 TL	117.000,00 TL

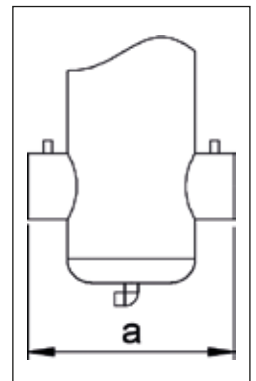
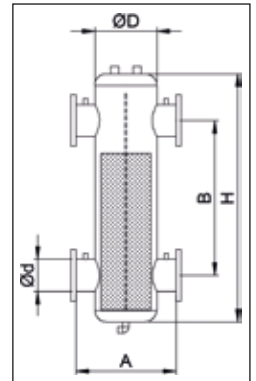

* ÜRÜNLERİMİZ - + %5 DEĞİŞKENLİK GÖSTEREBİLİR.

Merkez Ofis (Head Office): İstasyon Caddesi No:29 Bolvadin/Afyonkarahisar
Fabrika (Factory): Selçuklu Mahallesi Ticaret Bölgesi No:316 Bolvadin/Afyonkarahisar
Afyonkarahisar Şube (Branch): Karaman Mh. Alparslan Türkeş Cd. Hisar Apt. No:2/A Afyonkarahisar

Tel: 0 272 612 43 87
Fax: 0 272 612 63 80

web: www.teksanisi.com
e-mail: info@teksanisi.com

Tortu ve Pislik Tutucu & Manyetik Filtre

DIRT SEPARATOR & MAGNETIC FILTER



TEKSAN
ISI & DOĞALGAZ MÜHENDİSLİK



TR

Tortu ve Manyetik filtre, Merkezi sistemlerde tortu tutucu işlevine ek olarak, sistem içerisindeki sızıda bulunan metal parçacıkları toplarlar. flanşlı ve dişli olarak sisteme montajı yapılır ihtiyaca göre gövdede bulunan neodyum çubuk mıknatıs adetleri artırılıp eksiltilebilir mıknatıslar gövdenin dışında bulunan pirinç tapa sayesinde mıknatıslar, manyetik kir parçacıklarından arındırmak için çıkarılabilir. Bu sayede sistemde demir parçası, toru, çamur ve pislik tek ürün kullanılarak arındırılmış olur tortu çamur ve pislik temizliği ürün altında bulunan tahliye vanasından boşaltımı sağlanır

EN

Dirt separators and magnetic filter collects toxic metal in the system center, in addition to the torture inspection service in central systems. It is made systematically designed as a teaching method. These system systems are purified from iron part, toru, single devices and discharged from the drain valve consisting of the product purified from dirt cleaning.



MADE IN TURKEY

teknik detaylar technical details

KOD code	GİRİŞ-ÇIKIŞ in - out inç	GİRİŞ-ÇIKIŞ in - out DN	D mm	H cm	A mm	a mm	d mm	B mm	KAYNAKLI FIYAT/PRICE	FLANŞLI FIYAT/PRICE
TTMF 001	1"	DN 25	89	23	189	159	33,7	81,9	5.125,00 TL	
TTMF 002	1 1/4"	DN 32	89	23	189	159	46	73	5.250,00 TL	
TTMF 003	1 1/2"	DN 40	114	24	214	184	48,3	79,15	5.375,00 TL	6.375,00 TL
TTMF 004	2"	DN 50	114	37	234	204	60,3	115,15	6.000,00 TL	6.800,00 TL
TTMF 005	2 1/2"	DN 65	169	40	289	259	73	133,5	6.475,00 TL	7.250,00 TL
TTMF 006	3"	DN 80	219	38	409	379	88,9	174,5	8.625,00 TL	9.875,00 TL
TTMF 007	4"	DN 100	219	50	409	379	114,3	187,15	9.050,00 TL	10.500,00 TL
TTMF 008	5"	DN 125	273	56	463	433	141	210,5	10.300,00 TL	11.875,00 TL
TTMF 009	6"	DN 150	323	65,4	513	483	168,3	261,15	13.475,00 TL	19.200,00 TL
TTMF 010	8"	DN 200	406	96	698	646	219,1	349,6	21.325,00 TL	26.250,00 TL
TTMF 011	10"	DN 250	559	119	897	839	273	476,5	31.250,00 TL	39.750,00 TL
TTMF 012	12"	DN 300	610	137	954	890	323	516,5	45.000,00 TL	52.500,00 TL

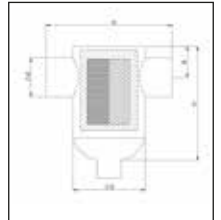
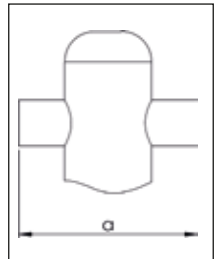
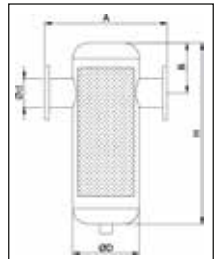

* ÜRÜNLERİMİZ - + %5 DEĞİŞKENLİK GÖSTEREBİLİR.

Merkez Ofis (Head Office): İstasyon Caddesi No:29 Bolvadin/Afyonkarahisar
Fabrika (Factory): Selçuklu Mahallesi Ticaret Bölgesi No:316 Bolvadin/Afyonkarahisar
Afyonkarahisar Şube (Branch): Karaman Mh. Alparslan Türkeş Cd. Hisar Apt. No:2/A Afyonkarahisar

Tel: 0 272 612 43 87
Fax: 0 272 612 63 80

web: www.teksanisi.com
e-mail: info@teksanisi.com

Manyetik Cepli Filtre

SHEATED MAGNETIC FILTER



Teksan Cepli Manyetik Filtre özel tasarımı sayesinde Neodyum Çubuklarının su ile teması engellenmektedir. Ürünün üst kısmından Tesisattan tamamen bağımsız olarak Neodyum Çubukları çıkarılabilir ve biriken metal, 304 Kalite Paslanmaz Cep sayesinde kolay bir şekilde mıknatıs temizliği yapılabilir.

Merkezi sistemler ve sıvı akışı olan tesisatlarda Tortu Tutucu işlemine ek olarak Neodyum Mıknatıs çubukları sayesinde, sıvı içerisinde bulunan metal parçaları toplar. Tesisat içerisinde bulunan Demir, Çamur, Partikül vb. ürünler bu sayede sudan arıtılmış olur Sistem üzerinde Korozyon engellenmesi ve sistemin düzenli çalışmasına fayda sağlamaktadır. Sirkülasyon Pompası, Kat Sistemi istasyonunda bulunan Termostatik Vana ve Isıtma Sisteminde bulunan Tüm cihaz ve ekipmanların sorunsuz olarak çalışmasına yardımcı olmakla birlikte enerji tüketimini azaltmakta olup, çalışan ekipmanların daha uzun süreli sorunsuz çalışmasını fayda sağlamaktadır. Flanşlı, Kaynaklı, Dişli olarak sistem ihtiyacına göre montaj yapılabilir. Kapak üzerinde bulunan Neodyum Çubukları ihtiyaç dahilinde artırılıp azaltılabilir. Mıknatıs ürün üzerinde haricen tasarlanmış kapak üzerine montajlanmış olup gövdeden kolay bir şekilde temizlenmesi mümkün hale getirilmiştir.



MADE IN TURKEY

teknik detaylar

technical details

KOD code	ÜRÜN AÇIKLAMA product description	GİRİŞ-ÇIKIŞ in - out inç	GİRİŞ-ÇIKIŞ in - out DN	Ø ÇAP diameter	BOY high	ÇUBUK SAYISI number of sticks	KAYNAKLI FİYAT / PRICE	FLANŞLI FİYAT / PRICE
TCMK 001	DİŞLİ CEPLİ MANYETİK FİLTRE	1"	DN 25	114	15	1	10.600,00 TL	
TCMK 002	DİŞLİ CEPLİ MANYETİK FİLTRE	1 1/4"	DN 32	114	15	1	11.000,00 TL	
TCMK 003	DİŞLİ CEPLİ MANYETİK FİLTRE	1 1/2"	DN 40	141	18	1	11.300,00 TL	12.900,00 TL
TCMK 004	DİŞLİ CEPLİ MANYETİK FİLTRE	2"	DN 50	141	20	1	12.300,00 TL	13.500,00 TL
TCMK 005	FLANŞLI CEPLİ MANYETİK FİLTRE	2 1/2"	DN 65	169	25	2	14.600,00 TL	15.500,00 TL
TCMK 006	FLANŞLI CEPLİ MANYETİK FİLTRE	3"	DN 80	169	30	2	17.600,00 TL	19.500,00 TL
TCMK 007	FLANŞLI CEPLİ MANYETİK FİLTRE	4"	DN 100	219	34	2	19.800,00 TL	22.950,00 TL
TCMK 008	FLANŞLI CEPLİ MANYETİK FİLTRE	5"	DN 125	219	36	2	21.900,00 TL	24.900,00 TL
TCMK 009	FLANŞLI CEPLİ MANYETİK FİLTRE	6"	DN 150	219	40	3	27.100,00 TL	36.200,00 TL
TCMK 010	FLANŞLI CEPLİ MANYETİK FİLTRE	8"	DN 200	323	45	4	52.800,00 TL	60.500,00 TL
TCMK 011	FLANŞLI CEPLİ MANYETİK FİLTRE	10"	DN 250	355	55	4	72.500,00 TL	93.500,00 TL
TCMK 012	FLANŞLI CEPLİ MANYETİK FİLTRE	12"	DN 300	457	60	4	123.000,00 TL	140.000,00 TL

* ÜRÜNLERİMİZ - + %5 DEĞİŞKENLİK GÖSTEREBİLİR.

Merkez Ofis (Head Office): İstasyon Caddesi No:29 Bolvadin/Afyonkarahisar
Fabrika (Factory): Selçuklu Mahallesi Ticaret Bölgesi No:316 Bolvadin/Afyonkarahisar
Afyonkarahisar Şube (Branch): Karaman Mh. Alparslan Türkeş Cd. Hisar Apt. No:2/A Afyonkarahisar

Tel.: 0 272 612 43 87
Fax: 0 272 612 63 80

web: www.teksanisi.com
e-mail: info@teksanisi.com

Standart Manyetik Filtre

STANDART MAGNETIC FILTER



Teksan Standart Manyetik Filtre Merkezi sistemler ve sıvı akışı olan tesisatlarda Tortu Tutucu işlemine ek olarak Neodyum Miknatis çubuklar sayesinde, sıvı içerisinde bulunan metal parçaları toplar. Tesisat içerisinde bulunan Demir, Çamur, Partikül vb. ürünler bu sayede sudan arıtılmış olur Sistem üzerinde Korozyon engellenmesi ve sistemin düzenli çalışmasına fayda sağlamaktadır. Sirkülasyon Pompası, Kat Sistemi istasyonunda bulunan Termostatik Vana ve Isıtma Sisteminde bulunan Tüm cihaz ve ekipmanların sorunsuz olarak çalışmasına yardımcı olmakla birlikte enerji tüketimini azaltmakta olup, çalışan ekipmanların daha uzun süreli sorunsuz çalışmasını fayda sağlamaktadır.

Flanşlı, Kaynaklı, Dişli olarak sistem ihtiyacına göre montaj yapılabilir. Kapak üzerinde bulunan Neodyum Çubuklar ihtiyaç dahilinde artırılıp azaltılabilir. Miknatis ürün üzerinde haricen tasarlanmış kapak üzerine montajlanmış olup gövdeden kolay bir şekilde temizlenmesi mümkün hale getirilmiştir.



MADE IN TURKEY

teknik detaylar technical details

KOD code	ÜRÜN AÇIKLAMA product description	GİRİŞ-ÇIKIŞ in - out inç	GİRİŞ-ÇIKIŞ in - out DN	Ø ÇAP diameter	BOY high	ÇUBUK SAYISI number of sticks	KAYNAKLI FIYAT / PRICE	FLANŞLI FIYAT / PRICE
TSMK 001	DİŞLİ STANDART MANYETİK FİLTRE	1"	DN 25	114	15	1	8.600,00 TL	
TSMK 002	DİŞLİ STANDART MANYETİK FİLTRE	1 ¼"	DN 32	114	15	1	8.730,00 TL	
TSMK 003	DİŞLİ STANDART MANYETİK FİLTRE	1 ½"	DN 40	141	18	1	9.350,00 TL	10.700,00 TL
TSMK 004	DİŞLİ STANDART MANYETİK FİLTRE	2"	DN 50	141	20	1	10.400,00 TL	11.350,00 TL
TSMK 005	FLANŞLI STANDART MANYETİK FİLTRE	2 ½"	DN 65	169	25	2	11.850,00 TL	12.850,00 TL
TSMK 006	FLANŞLI STANDART MANYETİK FİLTRE	3"	DN 80	169	30	2	14.550,00 TL	16.300,00 TL
TSMK 007	FLANŞLI STANDART MANYETİK FİLTRE	4"	DN 100	219	34	2	16.200,00 TL	17.950,00 TL
TSMK 008	FLANŞLI STANDART MANYETİK FİLTRE	5"	DN 125	219	36	2	17.900,00 TL	20.500,00 TL
TSMK 009	FLANŞLI STANDART MANYETİK FİLTRE	6"	DN 150	219	40	3	22.300,00 TL	29.300,00 TL
TSMK 010	FLANŞLI STANDART MANYETİK FİLTRE	8"	DN 200	323	45	4	42.950,00 TL	49.800,00 TL
TSMK 011	FLANŞLI STANDART MANYETİK FİLTRE	10"	DN 250	355	55	4	59.800,00 TL	69.700,00 TL
TSMK 012	FLANŞLI STANDART MANYETİK FİLTRE	12"	DN 300	457	60	4	94.600,00 TL	104.500,00 TL



* ÜRÜNLERİMİZ - + %5 DEĞİŞKENLİK GÖSTEREBİLİR.

Merkez Ofis (Head Office): İstasyon Caddesi No:29 Bolvadin/Afyonkarahisar
Fabrika (Factory): Selçuklu Mahallesi Ticaret Bölgesi No:316 Bolvadin/Afyonkarahisar
Afyonkarahisar Şube (Branch): Karaman Mh. Alparslan Türkeş Cd. Hisar Apt. No:2/A Afyonkarahisar

Tel.: 0 272 612 43 87
Fax: 0 272 612 63 80

web: www.teksanisi.com
e-mail: info@teksanisi.com



TEKSAN[®]
ISI & DOĞALGAZ MÜHENDİSLİK



Nötralizasyon Tankları

neutralization tanks



www.teksanisi.com

Nötralizasyon Tankı

NEUTRALIZATION TANK

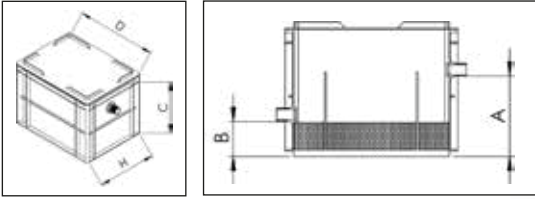
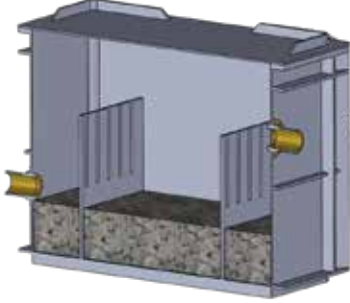

TR

Yanma sırasında meydana gelen kondensasyon ve baca gazlarının yogusması nedeni ile pH değerleri düşer kondens asidi ortaya çıkar. Kondense asidi oldukça ciddi ekolojik problemlere sebep olurken aynı zamanda ekonomizör, kazan ve mevcut boru tesisatı üzerinde ciddi hasarlara ve korozyona sebep olur. Nötralizasyon tankı bu atıkların pH değerini nötr hale getirerek bu problemi önler Nötralizasyon işlemi için en uygun yöntem asidik derecedeki kimyasal atığın kalsiyum karbonat içeren dilimlerle nötrleşme işlemidir. Kalsiyum karbonatlar (CaCO₃) suyun içerisinde asitlerle tepkimeye girerek zararsız doğal tuzlarla CO₂ açığa çıkar. Tuzlar tortular halinde dibine çökerken CO₂ ise suda çözünerek karbonik asitleri oluşturur. Oluşan karbonik asitler alkali atıkları pH 3'ten pH 5,5 pH 8,5 dereceleri arasına kadar yükselterek nötralize eder. Böylece atık su giderleri, kazan dairesi tesisatı ve en önemlisi eko sisteme ciddi zararlar verebilecek kimyasallar zararsız hale gelmiş olur.

EN

Due to the variation temperature of the Boiler and funnel system cause condensation water at heating systems. This low pH valued acidic and toxic water must be purified then drained to sewage systems The Teksan neutralization tank prevent the nature and the installation from this acidic and toxic water by turning them in to harmless and pH optimized water. The neutralization tank must be placed before this toxic water entering the sewage.

teknik detaylar technical details

KOD code	GÜÇ power KW	BAĞLANTI in - out inç	D cm	H cm	C cm	B cm	A cm	FİYAT PRICE
TNP 001	350 KW	1"	40	30	22	7	15	1.275,00 TL
TNP 002	550 KW	1"	40	30	30	10	20	1.437,00 TL
TNP 003	800 KW	1"	40	30	30	10	20	2.050,00 TL
TNP 004	1100 KW	1"	40	40	30	10	20	2.550,00 TL
TNP 005	1600 KW	1 1/4"	40	40	30	10	20	3.000,00 TL
TNP 006	2800 KW	1 1/4"	60	40	27	9	18	4.800,00 TL
TNP 007	3900 KW	1 1/2"	60	40	43	15	29	6.525,00 TL
TNP 008	4800 KW	1 1/2"	60	40	43	15	29	8.600,00 TL



MADE IN TURKEY

* ÜRÜNLERİMİZ - + %5 DEĞİŞKENLİK GÖSTEREBİLİR.

Merkez Ofis (Head Office): İstasyon Caddesi No:29 Bolvadin/Afyonkarahisar
Fabrika (Factory): Selçuklu Mahallesi Ticaret Bölgesi No:316 Bolvadin/Afyonkarahisar
Afyonkarahisar Şube (Branch): Karaman Mh. Alparslan Türkeş Cd. Hisar Apt. No:2/A Afyonkarahisar

Tel.: 0 272 612 43 87
Fax: 0 272 612 63 80

web: www.teksanisi.com
e-mail: info@teksanisi.com

Nötralizasyon Tankı

NEUTRALIZATION TANK



TEKSAN
ISI & DOĞALGAZ MÜHENDİSLİK

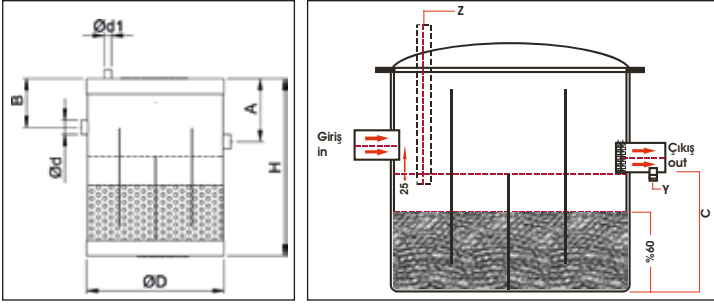

TR

Yanma sırasında meydana gelen kondensasyon ve baca gazlarının yoğunlaşması nedeni ile pH değerleri düşer kondens asidi ortaya çıkar. Kondens asidi oldukça ciddi ekolojik problemlere sebep olurken aynı zamanda ekonomizör , kazan ve mevcut boru tesisatı üzerinde ciddi hasarlara ve korozyona sebep olur. Nötralizasyon tankı bu atıkların pH değerini nötr hale getirerek bu problemi önler Nötralizasyon işlemi için en uygun yöntem asidik derecedeki kimyasal atığın kalsiyum karbonat içeren dilimlerle nötrleşme işlemidir. Kalsiyum karbonatlar (CaCO₃) suyun içerisinde asitlerle tepkimeye girerek zararsız doğal tuzlarla CO₂ açığa çıkar. Tuzlar tortular halinde dibine çökerken CO₂ ise suda çözünerek karbonik asitleri oluşturur. Oluşan karbonik asitler alkali atıkları pH 3'ten pH 5,5 pH 8,5 dereceleri arasına kadar yükselterek nötralize eder. Böylece atık su giderleri , kazan dairesi tesisatı ve en önemlisi eko sisteme ciddi zararlar verebilecek kimyasallar zararsız hale gelmiş olur.

EN

Due to the variation temperature of the Boiler and funnel system cause condensation water at heating systems. This low pH valued acidic and toxic water must be purified then drained to sewage systems. The Teksan neutralization tank prevents the nature and the installation from this acidic and toxic water by turning them into harmless and pH optimized water. The neutralization tank must be placed before this toxic water entering the sewage.

teknik detaylar technical details

KOD code	GÜÇ power kW	GİRİŞ - ÇIKIŞ in - out inç	MANŞON ejection inç	D cm	H cm	B cm	A cm	FİYAT PRICE
TNT 001	350 KW	1"	1/2"	40	30	14	16,5	5.100,00 TL
TNT 002	550 KW	1"	1/2"	40	35	14	16,5	5.750,00 TL
TNT 003	800 KW	1"	1/2"	40	40	14	16,5	8.200,00 TL
TNT 004	1100 KW	1"	1/2"	40	45	14	16,5	10.200,00 TL
TNT 005	1600 KW	1"	1/2"	40	50	14	16,5	12.000,00 TL
TNT 006	2800 KW	1 1/4"	1/2"	40	60	14	16,5	19.200,00 TL
TNT 007	3900 KW	1 1/2"	1/2"	50	40	14	16,5	26.100,00 TL

* ÜRÜNLERİMİZ - + %5 DEĞİŞKENLİK GÖSTEREBİLİR.



MADE IN TURKEY

Merkez Ofis (Head Office): İstasyon Caddesi No:29 Bolvadin/Afyonkarahisar
Fabrika (Factory): Selçuklu Mahallesi Ticaret Bölgesi No:316 Bolvadin/Afyonkarahisar
Afyonkarahisar Şube (Branch): Karaman Mh. Alparslan Türkeş Cd. Hisar Apt. No:2/A Afyonkarahisar

Tel: 0 272 612 43 87
Fax: 0 272 612 63 80

web: www.teksanisi.com
e-mail: info@teksanisi.com

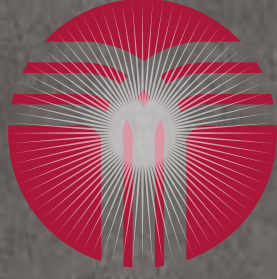

TEKSAN
ISI & DOĞALGAZ MÜHENDİSLİK



Flanş, Kep, Yağ Tutucu
flange, cap, oil trap



www.teksanisi.com

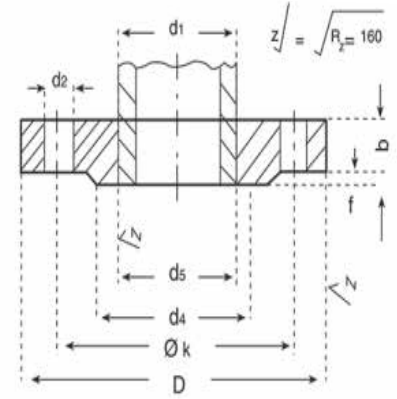

KAYNAK BOYUNLU FLANŞ

STANDART FLANŞ

teknik detaylar

KOD Code	inc	DN	İÇ ÇAP inner diameter	DIŞ ÇAP outer diameter	AGIRLIK weight	STANDART FLANŞ	KAY.BOY. FLANŞ
TFD001	1 1/4"	DN 32	15 mm	14 mm	1,35	226,00 TL	355,00 TL
TFD002	1 1/2"	DN 40	15 mm	14 mm	1,55	246,00 TL	380,00 TL
TFD003	2"	DN 50	15 mm	14 mm	1,8	269,00 TL	410,00 TL
TFD004	2 1/2"	DN 65	15 mm	14 mm	2,2	300,00 TL	460,00 TL
TFD005	3"	DN 80	15 mm	14 mm	2,25	320,00 TL	500,00 TL
TFD006	4"	DN 100	15 mm	14 mm	2,4	406,00 TL	615,00 TL
TFD007	5"	DN 125	15 mm	14 mm	3	509,00 TL	800,00 TL
TFD008	6"	DN 150	15 mm	14 mm	3,85	643,00 TL	975,00 TL
TFD009	8"	DN 200	20 mm	18,50 mm	6,55	1.973,00 TL	2.450,00 TL
TFD010	10"	DN 250	23 mm	22 mm	11	3.961,00 TL	4.550, 00 TL
TFD011	12"	DN 300	23 mm	22 mm	15	5.661,00 TL	6.400,00 TL



MADE IN TURKEY

* ÜRÜNLERİMİZ - + %5 DEĞİŞKENLİK GÖSTEREBİLİR.

Merkez Ofis (Head Office): İstasyon Caddesi No:29 Bolvadin/Afyonkarahisar
Fabrika (Factory):Selçuklu Mahallesi Ticaret Bölgesi No:316 Bolvadin/Afyonkarahisar
Afyonkarahisar Şube (Branch): Karaman Mh. Alparslan Türkeş Cd. Hisar Apt. No:2/A Afyonkarahisar

Tel.:0 272 612 43 87
Fax: 0 272 612 63 80

web: www.teksanisi.com
e-mail: info@teksanisi.com

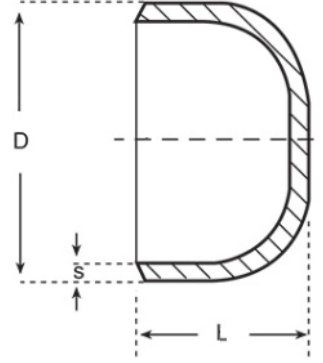

 teknik detaylar
technical details

KOD code	İNÇ	DN	ÜRÜN ÖZ. product features	D	L	AGIRLIK Kg weight kg.	KALINLIKS thickness s	FİYAT price
TKK001	1 1/2"	DN 40	SCH20	48,26	2,5 CM	0,15	2,5 MM	33,00 TL
TKK002	2"	DN 50	SCH20	60,3	2,5 CM	0,17	2,5 MM	36,00 TL
TKK003	2 1/2"	DN 65	SCH20	73,03	2,5 CM	0,2	3 MM	43,00 TL
TKK004	3"	DN 80	SCH20	88,9	2,5 CM	0,25	3 MM	46,00 TL
TKK005	4"	DN 100	SCH20	114,3	3 CM	0,35	3 MM	62,00 TL
TKK006	5"	DN 125	SCH20	141,3	5 CM	0,65	3 MM	103,00 TL
TKK007	6"	DN 150	SCH20	168,3	5,5 CM	1,25	4 MM	146,00 TL
TKK008	8"	DN 200	SCH20	219,1	6,5 CM	1,95	4 MM	310,00 TL
TKK009	10"	DN 250	SCH20	273	6,5 CM	2,7	4 MM	420,00 TL
TKK010	12"	DN 300	SCH20	323,9	9 CM	3	4 MM	800,00 TL
TKK011	14"	DN 350	SCH20	355,6	9 CM	5,3	4 MM	1.200,00 TL
TKK012	16"	DN 400	SCH20	406,4	11,5 CM	6	4 MM	1.330,00 TL
TKK013	18"	DN 450	SCH20	457,2	13,5 CM	8	4 MM	1.700,00 TL
TKK014	20"	DN 500	SCH20	508	17 CM	10	4 MM	1.920,00 TL
TKK015	22"	DN 550	SCH20	558,8	20 CM	13	4 MM	2.700,00 TL
TKK016	24"	DN 600	SCH20	609,5	23 CM	15	4 MM	3.400,00 TL



MADE IN TURKEY



 teknik detaylar
technical details

HAVA TÜPÜ

KOD code	KAPASİTE capacity	GİRİŞ-ÇIKIŞ inç.	H cm	D cm	FİYAT PRICE
THT 001	2 lt.	1/2"	14	14	437,50 TL
THT 002	3 lt.	1/2"	17	15	462,50 TL
THT 003	5 lt.	1/2"	19	19	487,50 TL
THT 004	10 lt.	1/2"	22	26	725,00 TL
THT 005	15 lt.	1/2"	27	35	1.050,00 TL
THT 006	20 lt.	1/2"	32	25	1.425,00 TL
THT 007	30 lt.	1/2"	32	38	2.125,00 TL

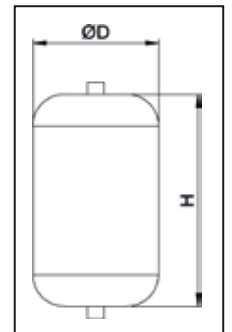

TR

Hava tüpü kalorifer tesisatındaki dolaşan suda oluşan havayı içerisinde toparlayıp, üst tarafındaki manşona bağlanan otomatik hava atıcı purjör sayesinde dışarıya atan yardımcı üründür

EN

Air tube evacuate the air from heating systems.

* ÜRÜNLERİMİZ - + %5 DEĞİŞKENLİK GÖSTEREBİLİR.





teknik detaylar

technical details

PASLANMAZ YAĞ TUTUCU

STAINLESS OIL SEPERATOR

KOD code	KAPASİTE capacity	GİRİŞ-ÇIKIŞ in-out inç.	A cm	B cm	H cm	FİYAT PRICE
TYT 001	7 lt.	Q 50	40	35	35	11.500,00 TL
TYT 002	15 lt.	Q 50	70	35	40	13.900,00 TL
TYT 003	20 lt.	Q 50	75	45	40	17.300,00 TL
TYT 004	48 lt.	Q 50	90	50	45	29.800,00 TL

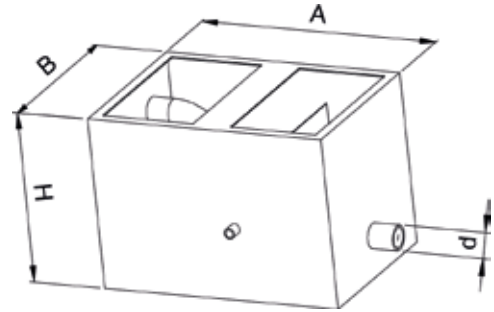

TR

Atık yağların herhangi bir arıtma olmadan direk kanalizasyona gönderilmesi ekolojik denge için çok tehlikelidir. Çünkü bir litre atık yağ on binlerce litre temiz suyu kirletebilir. Ayrıca donan atık yağlar tesisat giderlerinde tıkanıklıklara sebep olabilir. Teksan yağ tutucu atık yağları filtreleyerek doğaya ve tesisata verebileceği zararı önler

EN

The waste oils are seriously harming the nature and environment. Many countries strictly obey the use of Oil separators. Oil separators block the wasted oil in its own reservoir and saves the nature and environment. It must be cleaned regularly.

teknik detaylar

technical details

PLASTİK YAĞ TUTUCU

PLASTIC OIL SEPERATOR

KOD code	KAPASİTE capacity	GİRİŞ-ÇIKIŞ in-out inç.	A cm	B cm	H cm	FİYAT
TYP 001	5 lt.	Q 50	40	30	22	5.000,00 TL
TYP 002	7 lt.	Q 50	40	30	30	5.650,00 TL
TYP 003	10 lt.	Q 50	40	40	30	6.900,00 TL
TYP 004	12 lt.	Q 50	60	40	27	8.200,00 TL
TYP 005	20 lt.	Q 50	60	40	43	10.310,00 TL



MADE IN TURKEY



* ÜRÜNLERİMİZ - + %5 DEĞİŞKENLİK GÖSTEREBİLİR.

Merkez Ofis (Head Office): İstasyon Caddesi No:29 Bolvadin/Afyonkarahisar
Fabrika (Factory):Selçuklu Mahallesi Ticaret Bölgesi No:316 Bolvadin/Afyonkarahisar
Afyonkarahisar Şube (Branch): Karaman Mh. Alparslan Türkeş Cd. Hisar Apt. No:2/A Afyonkarahisar

Tel:0 272 612 43 87
Fax: 0 272 612 63 80

web: www.teksanisi.com
e-mail: info@teksanisi.com

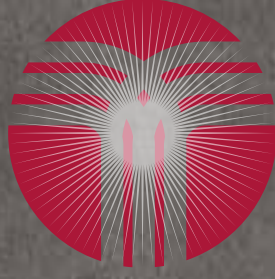

TEKSAN
ISI & DOĞALGAZ MÜHENDİSLİK



Boylar ve Tanklar
boiler and tanks

Akümülyasyon Tankı & Buffer Tank

ACCUMULATION TANK & BUFFER TANK



MADE IN TURKEY



TR

Akümülyasyon tankları ısıtma veya soğutma sistemlerinde ısıtılmış veya soğutulmuş kullanım suyunu hijyenik olarak depolayan tanklardır. Güneş enerjisi, ısı pompası, eşanjör, boyler, chiller, fancoil vb. ısı değiştirici cihazların ardına monte edilir. Ayrıca kullanım suyu depolanması harici fazla sıcak su tüketimi olan tesislerde ve ısı gerektiren prosesler için suyun depolanmasında kullanılır.

EN

The accumulation tanks can be use at heating or cooling systems. which is saves hot or cold usage water by the hygienically way



teknik detaylar

technical details

BUFFER TANK

* ÜRÜNLERİMİZ - + %5 DEĞİŞKENLİK GÖSTEREBİLİR.

KOD	KAPASİTE	İÇ ÇAP	DIŞ ÇAP	BOY	GİRİŞ - ÇIKIŞ ÇAP	İZALASYON	ELEKTRİK REZİSTANS BAĞLANTISI	TEMİZLEME FLANŞI	FİYAT
TBFT 001	80 LT	38 cm	45 cm	80 cm	1"	50 pu	1 1/4"	DN 80	10.600,00 TL
TBFT 002	100 LT	38 cm	45 cm	100 cm	1"	50 pu	1 1/4"	DN 80	14.550,00 TL
TBFT 003	160 LT	45 cm	52 cm	125 cm	1"	50 pu	1 1/4"	DN 80	15.700,00 TL
TBFT 004	200 LT	45 cm	52 cm	145 cm	1"	50 pu	1 1/4"	DN 80	18.400,00 TL
TBFT 005	300 LT	60 cm	67 cm	130 cm	1"	50 pu	1 1/4"	DN 80	20.800,00 TL
TBFT 006	500 LT	60 cm	67 cm	200 cm	1"	50 pu	1 1/4"	DN 80	30.350,00 TL

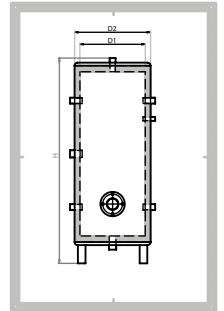

teknik detaylar

technical details

AKÜMÜLYASYON TANKI

KOD	KAPASİTE	ÇAP	BOY	MAGNEZYUM ANOT	SU GİRİŞ ÇIKIŞI	KALORİFER HATTI	ELEKTRİK BAĞLANTISI	TEMİZLEME FLANŞI	FİYAT
TTB 001	50 Lt.	40	75				1 1/4"		12.250,00 TL
TTB 002	100 Lt.	600	1100	1 1/4"	3/4"	1 1/4"	1 1/4"	DN 100	14.800,00 TL
TTB 003	160 Lt.	600	1100	1 1/4"	1"	1 1/4"	1 1/4"	DN 100	16.900,00 TL
TTB 004	200 Lt.	700	1300	1 1/4"	1"	1 1/4"	1 1/4"	DN 100	18.900,00 TL
TTB 005	300 Lt.	700	1150	1 1/4"	1 1/4"	1 1/4"	1 1/4"	DN 100	22.750,00 TL
TTB 006	400 Lt.	700	1900	1 1/4"	1 1/4"	1 1/4"	1 1/4"	DN 100	29.500,00 TL
TTB 007	500 Lt.	700	2050	1 1/4"	1 1/4"	1 1/4"	1 1/4"	DN 100	35.000,00 TL
TTB 008	600 Lt.	910	2100	1 1/4"	1 1/4"	1 1/4"	1 1/4"	DN 100	49.250,00 TL
TTB 009	800 Lt.	1000	2100	1 1/4"	1 1/4"	1 1/4"	1 1/4"	DN 100	64.400,00 TL
TTB 010	1000 Lt.	1250	1900	1 1/4"	1 1/4"	1 1/4"	1 1/4"	DN 100	72.500,00 TL
TTB 011	1500 Lt.	1250	2100	1 1/4"	1 1/4"	1 1/4"	1 1/4"	DN 100	102.000,00 TL
TTB 012	2000 Lt.	1250	2300	1 1/4"	1 1/4"	1 1/4"	1 1/4"	DN 100	122.500,00 TL

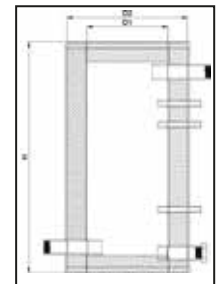

Merkez Ofis (Head Office): İstasyon Caddesi No:29 Bolvadin/Afyonkarahisar
Fabrika (Factory): Selçuklu Mahallesi Ticaret Bölgesi No:316 Bolvadin/Afyonkarahisar
Afyonkarahisar Şube (Branch): Karaman Mh. Alparslan Türkeş Cd. Hisar Apt. No:2/A Afyonkarahisar



Tel: 0 272 612 43 87
Fax: 0 272 612 63 80



web: www.teksanisi.com
e-mail: info@teksanisi.com

TR

Teksan boylar ısıtma cihazlarından elde edilen sıcak suyu ayrı bir bölümde kullanım suyu ile karıştırılmadan istenilen litrede depolama görevini kullanıcının isteği doğrultusunda sıcak su sunar. Teksan boylar farklı modellere sahip olup kılıflı, kılıfsız, dış yüzeyi paslanmaz olarak üretimi yapılmaktadır. İç depolama kısmı galvaniz olup, ekonomik ve hızlı ısınma konusunda siz ve sevdiğiniz bu rahatlığı tadını çıkarın.

EN

Teksan boiler is use for heating usage water at another division than central heating system by various capacity stoges. Teksan boilers have various models such as sheated, unshated and stainless steel covered. Inside tank made by galvanized steel. Teksan boilers are the best solutions at cheap and fast usage water heating



teknik detaylar

technical details

* ÜRÜNLERİMİZ - + %5 DEĞİŞKENLİK GÖSTEREBİLİR.

KOD	KAPASİTE	ÜRÜN CİNCİ	ÇAP	BOY	MAGNEZYUM ANOT	SU GİRİŞ ÇIKIŞI	KALORİFER HATTI	ELEKTRİK BAĞLANTISI	TEMİZLEME FLANŞI	FİYAT
TTB 001	100 Lt.	TEK SERPANTİN	500	1100	1 1/4"	3/4"	1"	1 1/4"	DN 100	18.460,00 TL
TTB 002	160 Lt.	TEK SERPANTİN	600	1100	1 1/4"	3/4"	1 1/4"	1 1/4"	DN 100	21.190,00 TL
TTB 003	200 Lt.	TEK SERPANTİN	600	1300	1 1/4"	1"	1 1/4"	1 1/4"	DN 100	24.570,00 TL
TTB 004	300 Lt.	TEK SERPANTİN	700	1150	1 1/4"	1"	1 1/4"	1 1/4"	DN 100	30.810,00 TL
TTB 005	400 Lt.	TEK SERPANTİN	700	1900	1 1/4"	1 1/4"	1 1/4"	1 1/4"	DN 100	42.120,00 TL
TTB 006	500 Lt.	TEK SERPANTİN	700	2050	1 1/4"	1 1/4"	1 1/4"	1 1/4"	DN 100	48.100,00 TL
TTB 007	600 Lt.	TEK SERPANTİN	700	2100	1 1/4"	1 1/4"	1 1/4"	1 1/4"	DN 100	66.300,00 TL
TTB 008	800 Lt.	TEK SERPANTİN	910	2100	1 1/4"	1 1/4"	1 1/4"	1 1/4"	DN 100	84.500,00 TL
TTB 009	1000 Lt.	TEK SERPANTİN	1000	1900	1 1/4"	1 1/4"	1 1/4"	1 1/4"	DN 100	91.500,00 TL
TTB 010	1500 Lt.	TEK SERPANTİN	1250	2100	1 1/4"	1 1/4"	1 1/4"	1 1/4"	DN 100	135.200,00 TL
TTB 011	2000 Lt.	TEK SERPANTİN	1250	2300	1 1/4"	1 1/4"	1 1/4"	1 1/4"	DN 100	153.400,00 TL

KOD	KAPASİTE	ÜRÜN CİNCİ	ÇAP	BOY	MAGNEZYUM ANOT	SU GİRİŞ ÇIKIŞI	KALORİFER HATTI	ELEKTRİK BAĞLANTISI	TEMİZLEME FLANŞI	FİYAT
TÇB 001	100 Lt.	ÇİFT SERPANTİN	500	1100	1 1/4"	3/4"	1"	1 1/4"	DN 100	20.540,00 TL
TÇB 002	160 Lt.	ÇİFT SERPANTİN	600	1100	1 1/4"	3/4"	1 1/4"	1 1/4"	DN 100	22.360,00 TL
TÇB 003	200 Lt.	ÇİFT SERPANTİN	600	1300	1 1/4"	1"	1 1/4"	1 1/4"	DN 100	24.700,00 TL
TÇB 004	300 Lt.	ÇİFT SERPANTİN	700	1150	1 1/4"	1"	1 1/4"	1 1/4"	DN 100	32.110,00 TL
TÇB 005	400 Lt.	ÇİFT SERPANTİN	700	1900	1 1/4"	1 1/4"	1 1/4"	1 1/4"	DN 100	44.590,00 TL
TÇB 006	500 Lt.	ÇİFT SERPANTİN	700	2050	1 1/4"	1 1/4"	1 1/4"	1 1/4"	DN 100	53.300,00 TL
TÇB 007	600 Lt.	ÇİFT SERPANTİN	700	2100	1 1/4"	1 1/4"	1 1/4"	1 1/4"	DN 100	61.800,00 TL
TÇB 008	800 Lt.	ÇİFT SERPANTİN	910	2100	1 1/4"	1 1/4"	1 1/4"	1 1/4"	DN 100	88.660,00 TL
TÇB 009	1000 Lt.	ÇİFT SERPANTİN	1000	1900	1 1/4"	1 1/4"	1 1/4"	1 1/4"	DN 100	100.880,00 TL
TÇB 010	1500 Lt.	ÇİFT SERPANTİN	1250	2100	1 1/4"	1 1/4"	1 1/4"	1 1/4"	DN 100	142.220,00 TL
TÇB 011	2000 Lt.	ÇİFT SERPANTİN	1250	2300	1 1/4"	1 1/4"	1 1/4"	1 1/4"	DN 100	167.960,00 TL



MADE IN TURKEY

Genleşme Tankı

EXPANSION TANK



MADE IN TURKEY



TR

Genleşme tankları, değişken sıcaklığın ve basıncın olduğu sistemlerde genleşme hacminin ayarlanmasını sağlar sistemdeki basıncı eşitler, içerisindeki EPDM membran ile iki bölüme ayrılmış tanklardır. Sistemin çalışma şekli - su sisteme girdiğinde sistemdeki basınç artar. Bu basınç arttıkça, genleşme tankında bulunan membran dış gövde ile arasında bulunan basınçlı hava sayesinde sisteme su geldiğinde tank içerisindeki hava sıkışır ve fazla suyun girmesi için alan oluşur sistemdeki basınç ayarını düzenler ve olası bir tehlikeyi engellemeye yardımcı olur. Bu şekilde Sistemdeki aşırı basınç azalır

EN

Multifunctional sanitary vessels are designed to be fitted both into sanitary system as expansion tanks, suitable to absorb the water expansion volume generated by a changing temperature, as well as tanks for cold water sanitary systems.

teknik detaylar technical details

Technical Specifications	
Production vessel volumes	2 - 5000 lt.
Max. working pressure	10 bar
Operating temperature	-10 / +100°C
Factory precharge (2-80 lt.)	3 bar
Factory precharge (100-5000lt)	4 bar
Raw material	High grade carbon steel
Membrane material (bladder)	EPDM/BUTYL
Coating (cover)	Electro-static powder coating
Types of vessels	Vertical, vertical with legs
Certifications	CE 97/23 PED directive, WRAS, EN 13831
Area of use	Multi water applications
Color	Blue / Red / White

KOD/CODE	ÜRÜN ADI/PRODUCT NAME	FİYAT/PRICE
TGT 001	8 LT AYAKSIZ DİK TANK	\$ 36,20
TGT 002	12 LT AYAKSIZ DİK TANK	\$ 38,25
TGT 003	18 LT AYAKSIZ DİK TANK	\$ 45,75
TGT 004	24 İTALYAN TİPİ BASIK KÜRE TANK	\$ 45,75
TGT 005	24 LT AYAKSIZ DİK TANK	\$ 48,75
TGT 006	24 LT AYAKLI ŞASE YATIK TANK	\$ 62,25
TGT 007	35 LT AYAKLI DİK TANK	\$ 66,75
TGT 008	50 LT AYAKLI DİK TANK	\$ 90,00
TGT 009	50 LT AYAKLI ŞASE YATIK TANK	\$ 90,00
TGT 010	60 LT AYAKLI DİK TANK	\$ 108,75
TGT 011	60 LT AYAKLI ŞASELİ YATIK TANK	\$ 108,75
TGT 012	80 LT AYAKLI DİK TANK	\$ 144,75
TGT 013	80 LT AYAKLI ŞASELİ YATIK TANK	\$ 144,75
TGT 014	100 LT AYAKLI DİK TANK MANOMETRELİ	\$ 170,25
TGT 015	100 LT AYAKLI ŞASELİ YATIK TANK	\$ 170,25
TGT 016	150 LT AYAKLI DİK TANK MANOMETRELİ	\$ 240,75
TGT 017	200 LT AYAKLI DİK TANK MANOMETRELİ	\$ 318,00
TGT 018	300 LT AYAKLI DİK TANK MANOMETRELİ	\$ 393,75
TGT 019	500 LT AYAKLI DİK TANK MANOMETRELİ	\$ 590,25
TGT 020	750 LT AYAKLI DİK TANK MANOMETRELİ	\$ 833,25
TGT 021	1000 LT AYAKLI DİK TANK MANOMETRELİ	\$ 1.211,25
TGT 022	1500 AYAKLI DİK TANK MANOMETRELİ	\$ 2.055,00
TGT 023	2000 LT AYAKLI DİK TANK MANOMETRELİ	\$ 2.670,00

* ÜRÜNLERİMİZ - + %5 DEĞİŞKENLİK GÖSTEREBİLİR.

Merkez Ofis (Head Office): İstasyon Caddesi No:29 Bolvadin/Afyonkarahisar
Fabrika (Factory): Selçuklu Mahallesi Ticaret Bölgesi No:316 Bolvadin/Afyonkarahisar
Afyonkarahisar Şube (Branch): Karaman Mh. Alparslan Türkeş Cd. Hisar Apt. No:2/A Afyonkarahisar

Tel.: 0 272 612 43 87
Fax: 0 272 612 63 80

web: www.teksanisi.com
e-mail: info@teksanisi.com

Kaskad Kazan Bağlantı Seti

CASCADE BOILER CONNECTION SET



TKKS 001
KASKAD KAZAN
TEKLİ BAĞLANTI SETİ
KASKAD BOILER
SINGLE CONNECTION

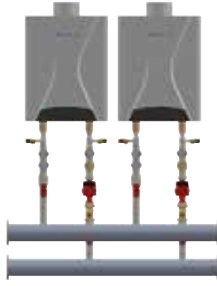

TKKS 002
KASKAD KAZAN
İKİLİ BAĞLANTI SETİ
KASKAD BOILER
DOUBLE CONNECTION

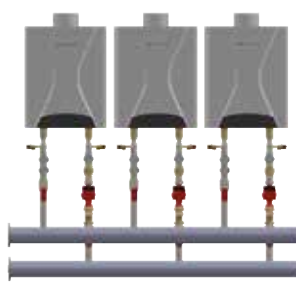

TKKS 003
KASKAD KAZAN
ÜÇLÜ BAĞLANTI SETİ
KASKAD BOILER
TRIBLE CONNECTION

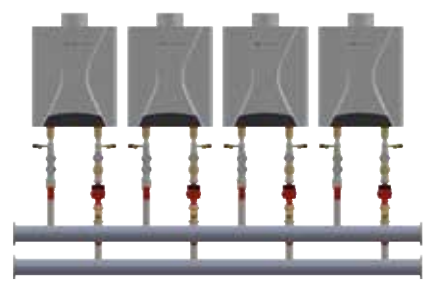

TKKS 004
KASKAD KAZAN
DÖRTLÜ BAĞLANTI SETİ
KASKAD BOILER
QUADRUPLE CONNECTION

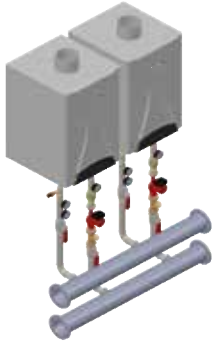

KOD code	ÜRÜN ADI product name	FİYAT PRICE
TKKS 001	KASKAD KAZAN TEKLİ BAĞLANTI SETİ / KASKAD BOILER SINGLE CONNECTION	FİYAT SORUNUZ
TKKS 002	KASKAD KAZAN İKİLİ BAĞLANTI SETİ / KASKAD BOILER DOUBLE CONNECTION	FİYAT SORUNUZ
TKKS 003	KASKAD KAZAN ÜÇLÜ BAĞLANTI SETİ / KASKAD BOILER TRIBLE CONNECTION	FİYAT SORUNUZ
TKKS 004	KASKAD KAZAN DÖRTLÜ BAĞLANTI SETİ / KASKAD BOILER QUADRUPLE CONNECTION	FİYAT SORUNUZ

KOD code	ÜRÜN ADI product name	FİYAT PRICE
TKKH 001	KASKAD KAZAN HİDROLİK BAĞLANTI SETİ / KASKAD BOILER HYDRAULIC CONNECTION SET	FİYAT SORUNUZ



MADE IN TURKEY

KOD code	ÜRÜN ADI product name	FİYAT PRICE
TKKK 001	KASKAD KAZAN TEKLİ KOLLEKTÖR GRUBU CASCADE BOILER SINGLE COLLECTOR GROUP	FİYAT SORUNUZ
TKKK002	KASKAD KAZAN İKİLİ KOLLEKTÖR GRUBU CASCADE BOILER DOUBLE COLLECTOR GROUP	FİYAT SORUNUZ
TKKK 003	KASKAD KAZAN ÜÇLÜ KOLLEKTÖR GRUBU CASCADE BOILER TRIPLE COLLECTOR GROUP	FİYAT SORUNUZ
TKKK 004	KASKAD KAZAN DÖRTLÜ KOLLEKTÖR GRUBU CASCADE BOILER QUADRUPLE COLLECTOR GROUP	FİYAT SORUNUZ

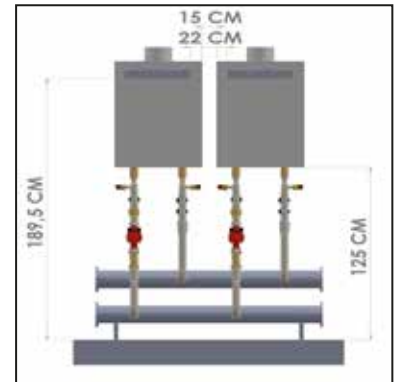

* ÜRÜNLERİMİZ - + %5 DEĞİŞKENLİK GÖSTEREBİLİR.

Merkez Ofis (Head Office): İstasyon Caddesi No:29 Bolvadin/Afyonkarahisar
Fabrika (Factory):Selçuklu Mahallesi Ticaret Bölgesi No:316 Bolvadin/Afyonkarahisar
Afyonkarahisar Şube (Branch): Karaman Mh. Alparslan Türkeş Cd. Hisar Apt. No:2/A Afyonkarahisar

Tel:0 272 612 43 87
Fax: 0 272 612 63 80

web: www.teksanisi.com
e-mail: info@teksanisi.com

Kazan Yumuşatma Cihazı & Bağ Filtre

BOILER SOFTENING DEVICE & BOND FILTER



MODEL model	KAPASİTE 40 m/h capacity 40 m/h	MİNERAL REÇİNE/LT mineral resin/lt	BAĞLANTI İNÇ connection inç	TANK B. İNÇ tank size inç	ÖLÇÜLER CM. tdimension cm.	FİYAT PRICE
TKSY 001	0,32 m ³ / h	8	1"	0,8"X 17"	30*48*72	\$ 620,00
TKSY 002	0,80 m ³ / h	20	1"	0,8"X 35"	30*48*118	\$ 780,00
TKSY 003	1,2 m ³ / h	30	1"	10"X 35"	30*48*118	\$ 870,00
TKSY 004	2 m ³ / h	50	1"	10"X 54"	257*1390	\$ 990,00
TKSY 005	2,4 003	60	1"	12"X 48"	307*1342	\$ 1.120,00

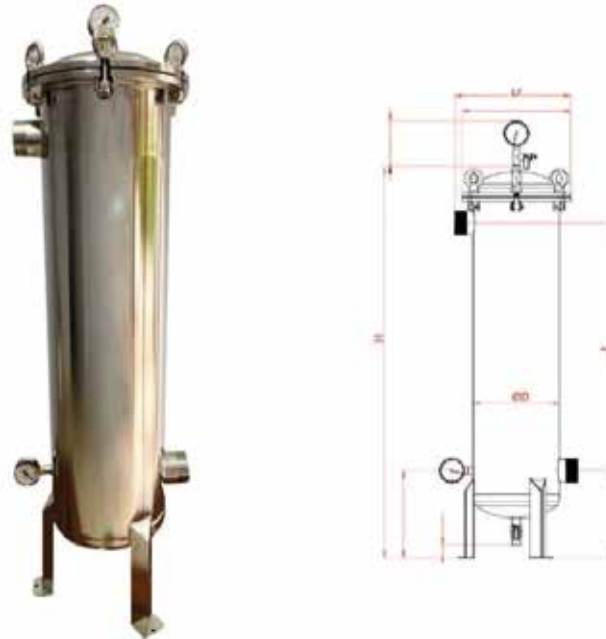

MADE IN TURKEY

MODEL model	KAPASİTE m ³ /h capacity m ³ /h	BAĞLANTI DN İNÇ connection DN İNÇ	ÖLÇÜLER dimension	FİYAT PRICE
D	H	L	LF	
TBF 001	6 m ³ / h	DN 50 2"	DN 219 1111 MM 222 MM 298 MM	\$ 985,00

* ÜRÜNLERİMİZ - + %5 DEĞİŞKENLİK GÖSTEREBİLİR.

Merkez Ofis (Head Office): İstasyon Caddesi No:29 Bolvadin/Afyonkarahisar
Fabrika (Factory):Selçuklu Mahallesi Ticaret Bölgesi No:316 Bolvadin/Afyonkarahisar
Afyonkarahisar Şube (Branch): Karaman Mh. Alparslan Türkeş Cd. Hisar Apt. No:2/A Afyonkarahisar

Tel:0 272 612 43 87
Fax: 0 272 612 63 80

web: www.teksanisi.com
e-mail: info@teksanisi.com

sertifikalar

certificates





TEKSAN[®]
ISI & DOĞALGAZ MÜHENDİSLİK



“Büyük işler büyük sorumluluk ister”

“Business need reliability”



Merkez Ofis (Head Office)

İstasyon Caddesi No:29 Bolvadin/Afyonkarahisar

Fabrika (Factory)

Selçuklu Mahallesi Ticaret Bölgesi No:316

Bolvadin/Afyonkarahisar

Afyonkarahisar Şube (Branch)

Karaman Mh. Alparslan Türkeş Cd. Hisar Apt. No:2/A

Afyonkarahisar

Tel.:0 272 612 43 87 Fax: 0 272 612 63 80

web: www.teksanisi.com e-mail: info@teksanisi.com



www.teksanisi.com

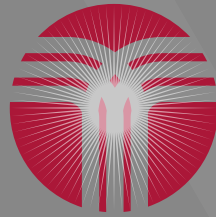

TEKSAN®

ISI & DOĞALGAZ MÜHENDİSLİK



Merkez Ofis (Head Office)

İstasyon Caddesi No:29 Bolvadin/Afyonkarahisar

Fabrika (Factory)

Selçuklu Mahallesi Ticaret Bölgesi No:316

Bolvadin/Afyonkarahisar

Afyonkarahisar Şube (Branch)

Karaman Mh. Alparslan Türkeş Cd. Hisar Apt. No:2/A

Afyonkarahisar

Tel.:0 272 612 43 87 Fax: 0 272 612 63 80

web: www.teksanisi.com e-mail: info@teksanisi.com